



STINGER 80-126

80T Lifting capacity
Boom truck crane

STINGER 80-126



Features: STINGER 80-126

- 80 USt @ 10 ft
- 126 ft maximum boom length
- 136 ft maximum tip height
- 33-57 ft optional offsettable jib
- 193 ft maximum tip height with 57 ft jib
- Tilting operator cab (0 - 18 degrees)
- Electronic rated capacity indicator
- Quick reeve boom head

DIMENSIONS

STINGER 80-126

Crane Dimensions

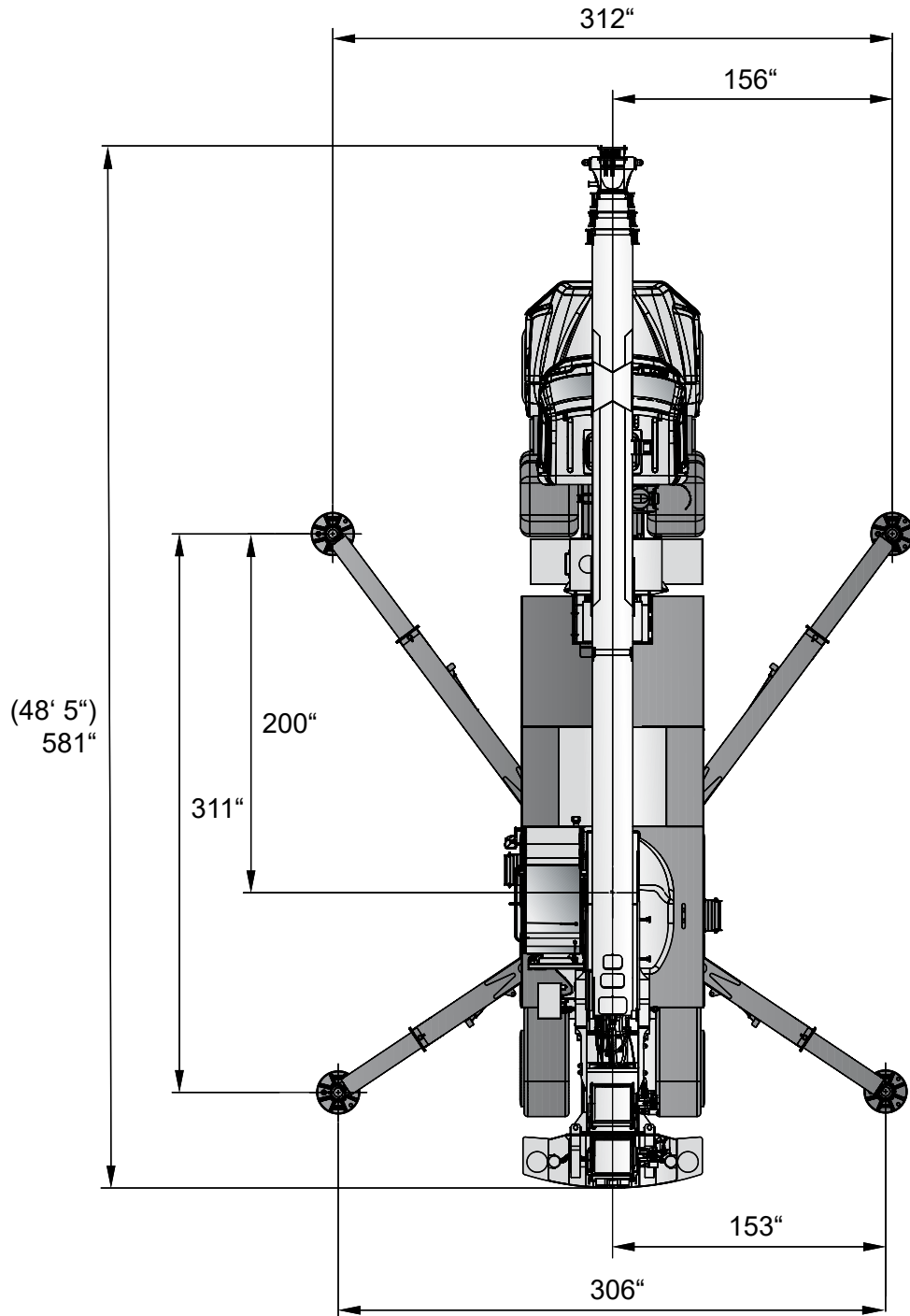

DIMENSIONS

STINGER 80-126

Crane Dimensions

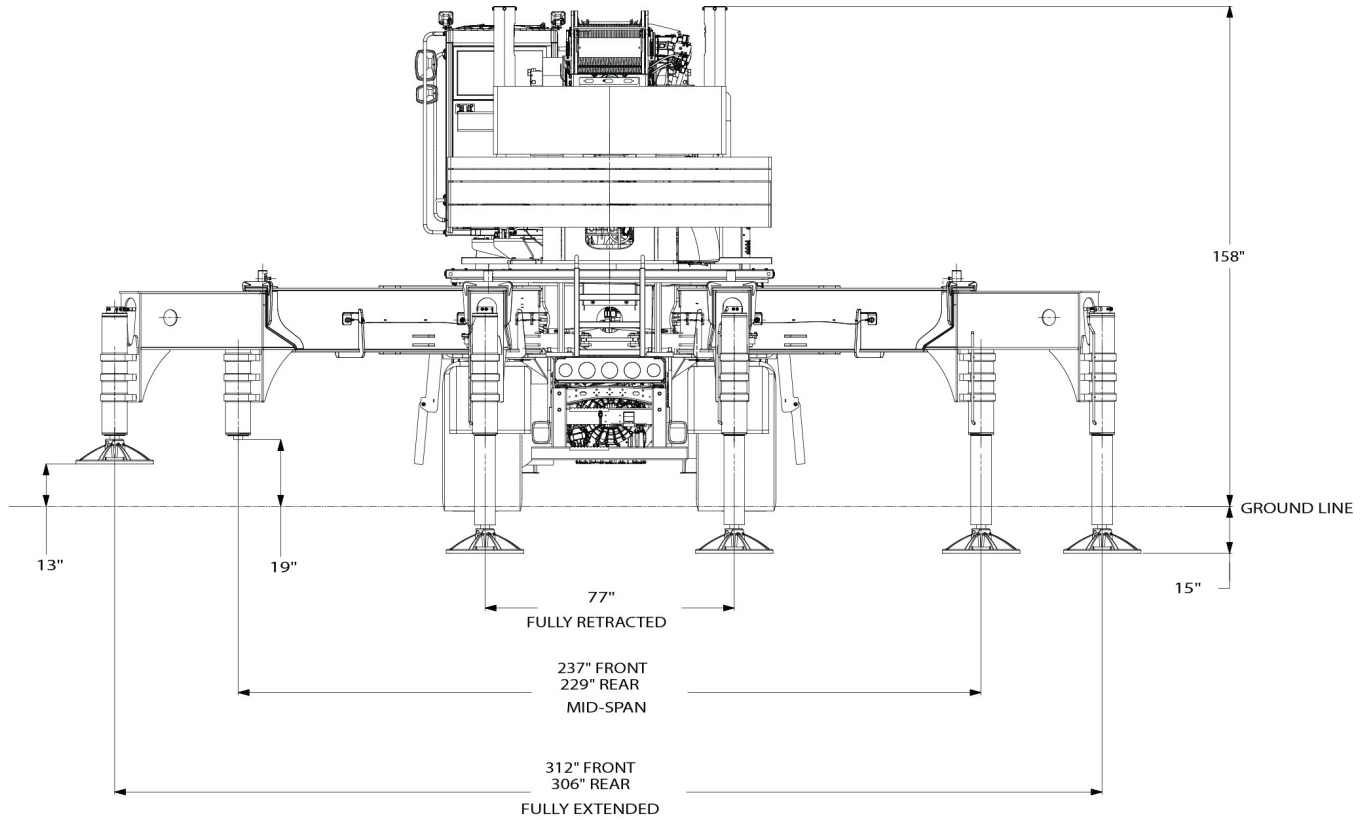

DIMENSIONS

STINGER 80-126

Crane Dimensions

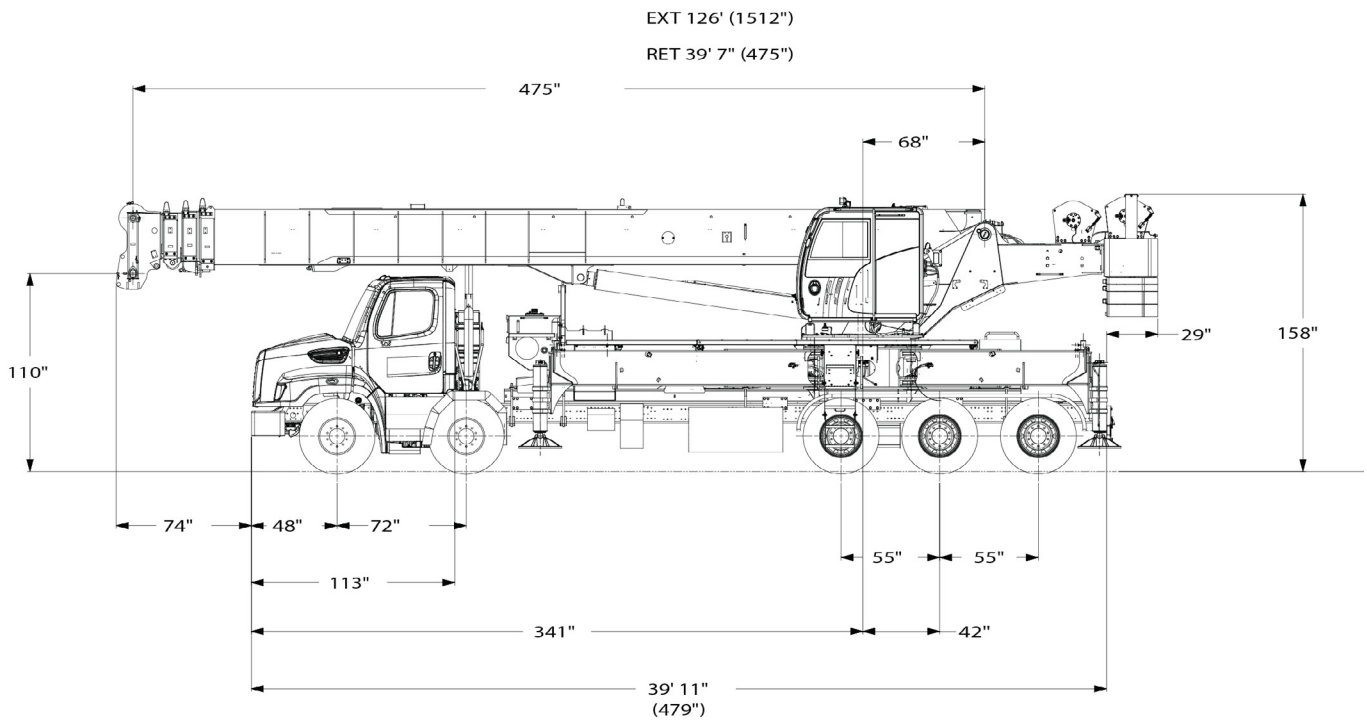

All Chassis Must be Pre-Approved by Factory

DIMENSIONS

STINGER 80-126

Crane Dimensions with Boom Dolly

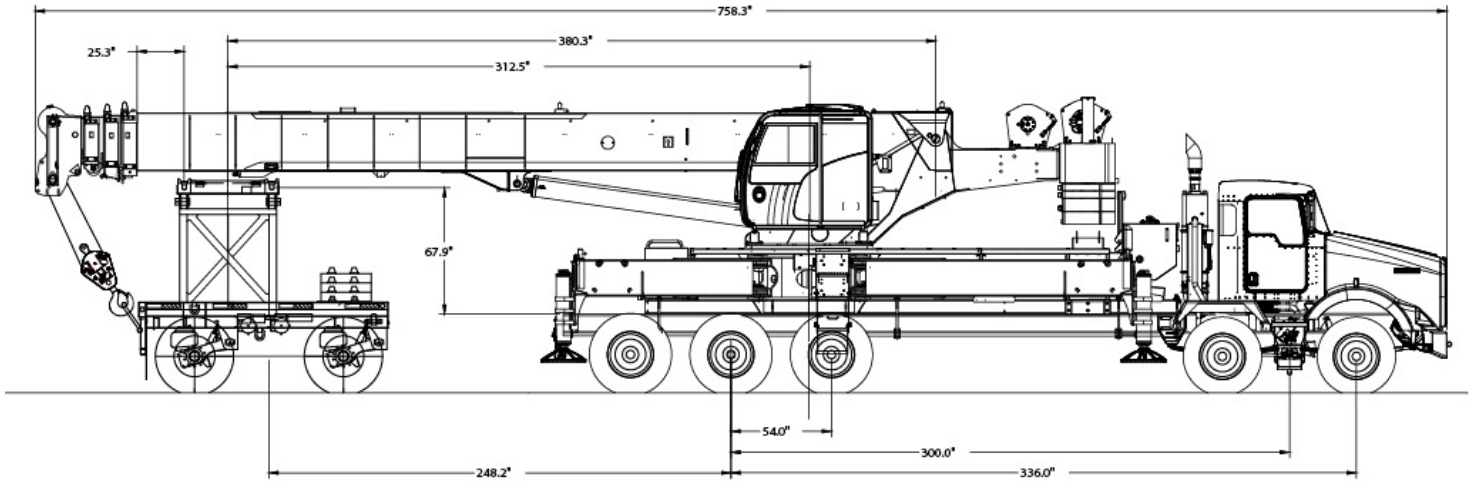





Estimated Axle Weight Distributions
Gross Wt. = 106,507 lbs

Configuration (Counterweights:)	Tandem Front Axles	Tridem Rear Axles	Dolly
ALL WEIGHT ON UPPER	34,501	52,620	19,386
4000 LBS ON DOLLY	31,818	51,303	23,386
8000 LBS ON DOLLY	29,264	49,857	27,386
10000 LBS ON DOLLY	27,987	49,134	29,386
12000 LBS ON DOLLY	26,710	48,411	31,386

SPECIFICATIONS

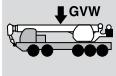
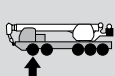
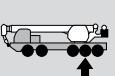
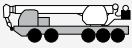
STINGER 80-126

Approximate Crane Weights

			
Configuration:  1/4 tank fuel 200 lb operator seated in driver's cab 126 ft boom / no jib Base counterweight Aux winch	60,521	21,564	38,957
Options:			
 Full fuel tank	750	250	500
 33'-57' extendable jib	2,230	1,881	289
32' jib	1,270	1,228	42
 80 ton 5 sheave block at bumper	1,608	2,246	-638
60 ton 5 sheave block at bumper	1,204	1,798	-594
12 ton O-ball at bumper	420	578	-158
 2000 lb counterweight on superstructure	2,000	-717	2,717
2000 lb on storage rack	2,000	1,277	723
4000 lb counterweight on superstructure	4,000	-1,434	5,434
4000 lb on storage rack	4,000	2,554	1,446
Bare chassis (EST)	24,615	13,875	10,740

RANGE DIAGRAM

STINGER 80-126

Outriggers Fully Extended

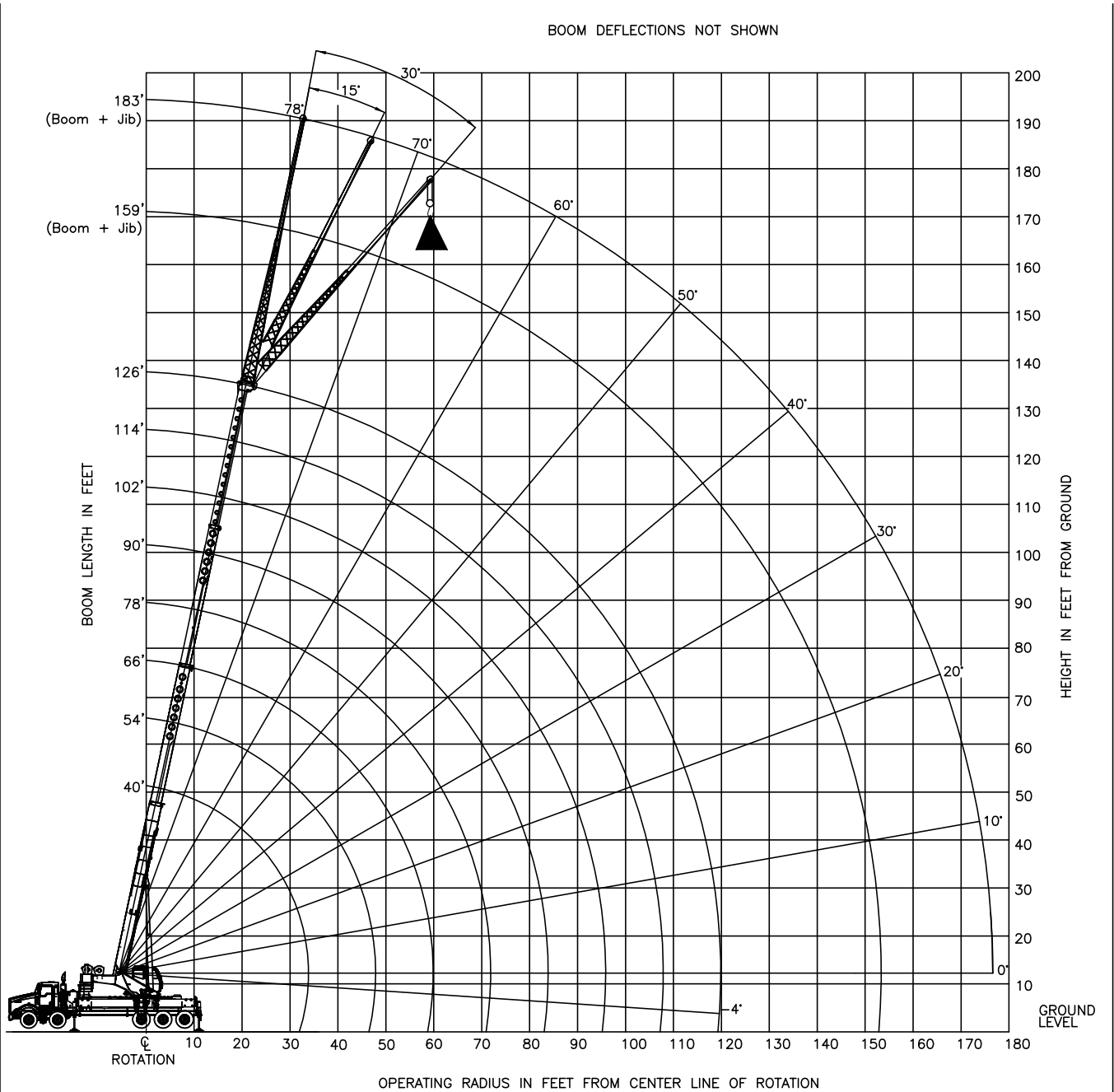
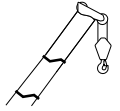

Operating radius from center line of rotation

LOAD CHART

STINGER 80-126

Outriggers Fully Extended

 15,000 lbs

 (100%)

 360°

 40 to 126 ft

Standard ASME
B30.5

	Boom Length								
	40 ft	54 ft	66 ft	78 ft	90 ft	102 ft	114 ft	126 ft	
ft	lbs	lbs	lbs	lbs	lbs	lbs	lbs	lbs	ft
10	160000	102500							10
12	125600	102500							12
15	108800	100500	80600						15
20	84500	85300	71900	62200	56200				20
25	65400	66400	64800	55700	48000	41900			25
30	52600	53700	54200	49700	41700	36400	31500		30
35		44500	45000	43800	36600	32100	29500	24700	35
40		35200	35700	36000	32800	28600	26200	24600	40
45		28200	28800	29100	29300	25700	23500	22100	45
50			23700	24100	24300	23400	21400	20000	50
55			19800	20300	20400	20600	19500	18200	55
60				17200	17400	17500	17600	16600	60
65				14700	15000	15100	15200	15200	65
70				12600	12900	13100	13200	13300	70
75					11200	11400	11500	11600	75
80					9700	9900	10000	10100	80
85						8600	8800	8900	85
90						7500	7700	7800	90
95						6500	6700	6800	95
100							5800	6000	100
105							5000	5200	105
110								4500	110
115								3900	115

Notes to lifting capacity

Lifting capacities do not exceed 85% of tipping load. Weight of hook blocks and slings are part of the load, and are to be deducted from the capacity ratings. Consult operation manual for further details.

Note: Data published herein is intended as a guide only and shall not be construed to warrant applicability for lifting purposes. Crane operation is subject to the computer charts and operation manual both supplied with the crane.

LOAD CHART

STINGER 80-126

Outriggers Fully Extended

 11,000 lbs

 (100%)

 360°

 40 to 126 ft

Standard ASME
B30.5

	Boom Length								
	40 ft	54 ft	66 ft	78 ft	90 ft	102 ft	114 ft	126 ft	
ft	lbs	lbs	lbs	lbs	lbs	lbs	lbs	lbs	ft
10	160000	102500							10
12	125600	102500							12
15	108800	100500	80600						15
20	82000	83100	71900	62200	56200				20
25	63400	64500	64800	55700	48000	41900			25
30	50900	52000	52600	49700	41700	36400	31500		30
35		41300	41700	42000	36600	32100	29500	24700	35
40		32000	32500	32800	32800	28600	26200	24600	40
45		25500	26100	26400	26600	25700	23500	22100	45
50			21400	21800	21900	22100	21400	20000	50
55			17800	18200	18400	18500	18600	18200	55
60				15300	15600	15700	15800	15900	60
65				13000	13300	13400	13500	13600	65
70				11100	11400	11600	11700	11700	70
75					9800	10000	10100	10200	75
80					8400	8600	8700	8800	80
85						7400	7500	7600	85
90						6400	6500	6600	90
95						5400	5500	5600	95
100							4700	4800	100
105							4000	4100	105
110								3400	110
115								2900	115

Notes to lifting capacity

Lifting capacities do not exceed 85% of tipping load. Weight of hook blocks and slings are part of the load, and are to be deducted from the capacity ratings. Consult operation manual for further details.

Note: Data published herein is intended as a guide only and shall not be construed to warrant applicability for lifting purposes. Crane operation is subject to the computer charts and operation manual both supplied with the crane.

LOAD CHART

STINGER 80-126

Outriggers Fully Extended

 7,000 lbs

 (100%)

 360°

 40 to 126 ft

Standard ASME
B30.5

	Boom Length								
	40 ft	54 ft	66 ft	78 ft	90 ft	102 ft	114 ft	126 ft	
ft	lbs	lbs	lbs	lbs	lbs	lbs	lbs	lbs	ft
10	149300	102500							10
12	125600	102500							12
15	108800	100500	80600						15
20	79600	80600	71900	62200	56200				20
25	61500	62500	63000	55700	48000	41900			25
30	49300	50400	50900	49700	41700	36400	31500		30
35		37400	37800	38100	36600	32100	29500	24700	35
40		28800	29300	29600	29800	28600	26200	24600	40
45		22800	23500	23700	23900	24100	23500	22100	45
50			19100	19400	19600	19800	19900	20000	50
55			15800	16200	16400	16500	16600	16700	55
60				13500	13800	13900	14000	14100	60
65				11400	11700	11800	11900	12000	65
70				9600	9900	10100	10200	10300	70
75					8400	8600	8700	8800	75
80					7100	7300	7500	7600	80
85						6300	6400	6500	85
90						5300	5500	5600	90
95						4400	4600	4700	95
100							3900	4000	100
105							3200	3300	105
110								2700	110
115								2200	115

Notes to lifting capacity

Lifting capacities do not exceed 85% of tipping load. Weight of hook blocks and slings are part of the load, and are to be deducted from the capacity ratings. Consult operation manual for further details.

Note: Data published herein is intended as a guide only and shall not be construed to warrant applicability for lifting purposes. Crane operation is subject to the computer charts and operation manual both supplied with the crane.

LOAD CHART

STINGER 80-126

Outriggers Fully Extended

 5,000 lbs

 (100%)

 360°

 40 to 126 ft

Standard ASME
B30.5

	Boom Length								
	40 ft	54 ft	66 ft	78 ft	90 ft	102 ft	114 ft	126 ft	
ft	lbs	lbs	lbs	lbs	lbs	lbs	lbs	lbs	ft
10	148200	102500							10
12	125600	102500							12
15	108000	100500	80600						15
20	78400	79400	71900	62200	56200				20
25	60500	61500	62100	55700	48000	41900			25
30	47400	48700	49200	49500	41700	36400	31500		30
35		35800	36200	36500	36600	32100	29500	24700	35
40		27500	28000	28300	28500	28600	26200	24600	40
45		21700	22400	22600	22800	23000	23100	22100	45
50			18200	18500	18700	18800	18900	19000	50
55			14900	15300	15500	15600	15700	15800	55
60				12800	13000	13100	13200	13300	60
65				10700	11000	11100	11200	11300	65
70				9000	9300	9400	9500	9600	70
75					7800	8000	8100	8200	75
80					6600	6800	7000	7000	80
85						5800	5900	6000	85
90						4800	5000	5100	90
95						4000	4200	4300	95
100							3500	3600	100
105							2800	2900	105
110								2400	110
115								1800	115

Notes to lifting capacity

Lifting capacities do not exceed 85% of tipping load. Weight of hook blocks and slings are part of the load, and are to be deducted from the capacity ratings. Consult operation manual for further details.

Note: Data published herein is intended as a guide only and shall not be construed to warrant applicability for lifting purposes. Crane operation is subject to the computer charts and operation manual both supplied with the crane.

LOAD CHART

STINGER 80-126

Outriggers Fully Extended

 3,000 lbs

 (100%)

 360°

 40 to 126 ft

Standard ASME
B30.5

	Boom Length								
	40 ft	54 ft	66 ft	78 ft	90 ft	102 ft	114 ft	126 ft	
ft	lbs	lbs	lbs	lbs	lbs	lbs	lbs	lbs	ft
10	140000	102500							10
12	125600	102500							12
15	106400	100500	80600						15
20	77200	78200	71900	62200	56200				20
25	59500	60600	61100	55700	48000	41900			25
30	44900	46200	46600	47000	41700	36400	31500		30
35		33800	34200	34500	34700	32100	29500	24700	35
40		25900	26400	26700	26900	27000	26200	24600	40
45		20300	21000	21300	21400	21600	21700	21800	45
50			17000	17300	17500	17600	17700	17800	50
55			13800	14300	14400	14600	14700	14800	55
60				11800	12100	12200	12300	12400	60
65				9800	10100	10200	10300	10400	65
70				8200	8500	8700	8800	8800	70
75					7100	7300	7400	7500	75
80					5900	6100	6300	6300	80
85						5100	5300	5400	85
90						4200	4400	4500	90
95						3400	3600	3700	95
100							2900	3000	100
105							2300	2400	105
110								1900	110
115								1400	115

Notes to lifting capacity

Lifting capacities do not exceed 85% of tipping load. Weight of hook blocks and slings are part of the load, and are to be deducted from the capacity ratings. Consult operation manual for further details.

Note: Data published herein is intended as a guide only and shall not be construed to warrant applicability for lifting purposes. Crane operation is subject to the computer charts and operation manual both supplied with the crane.

LOAD CHART

STINGER 80-126

Mid Span Outriggers

 15,000 lbs

 (50%)

 360°

 40 to 126 ft

Standard ASME
B30.5

	Boom Length								
	40 ft	54 ft	66 ft	78 ft	90 ft	102 ft	114 ft	126 ft	
ft	lbs	lbs	lbs	lbs	lbs	lbs	lbs	lbs	ft
10	139900	102500							10
12	122800	102500							12
15	102900	100500	80600						15
20	76400	77500	71900	62200	56200				20
25	48200	49400	49800	50100	48000	41900			25
30	33700	35100	35500	35800	36000	36100	31500		30
35		25600	26100	26400	26600	26700	26900	24700	35
40		19300	19800	20100	20300	20400	20600	20600	40
45		14800	15500	15700	15900	16100	16200	16300	45
50			12200	12500	12700	12900	13000	13100	50
55			9700	10100	10300	10400	10500	10600	55
60				8100	8400	8500	8600	8700	60
65				6500	6800	6900	7000	7100	65
70				5100	5400	5600	5700	5800	70
75					4300	4500	4600	4700	75
80					3300	3600	3700	3800	80
85						2700	2900	3000	85
90						2000	2200	2300	90

Notes to lifting capacity

Lifting capacities do not exceed 85% of tipping load. Weight of hook blocks and slings are part of the load, and are to be deducted from the capacity ratings. Consult operation manual for further details.

Note: Data published herein is intended as a guide only and shall not be construed to warrant applicability for lifting purposes. Crane operation is subject to the computer charts and operation manual both supplied with the crane.

LOAD CHART

STINGER 80-126

Mid Span Outriggers



11,000 lbs



(50%)



360°



40 to 126 ft

Standard ASME
B30.5

	Boom Length								
	40 ft	54 ft	66 ft	78 ft	90 ft	102 ft	114 ft	126 ft	
ft	lbs	lbs	lbs	lbs	lbs	lbs	lbs	lbs	ft
10	137700	102500							10
12	120600	102500							12
15	100900	100500	80600						15
20	69100	70100	70700	62200	56200				20
25	43200	44400	44800	45200	45400	41900			25
30	29900	31200	31700	32000	32200	32400	31500		30
35		22300	22800	23100	23300	23400	23500	23600	35
40		16500	17100	17400	17600	17700	17800	17900	40
45		12500	13100	13400	13600	13700	13900	13900	45
50			10200	10500	10700	10800	11000	11000	50
55			7900	8300	8500	8600	8700	8800	55
60				6500	6700	6900	7000	7100	60
65				5000	5300	5400	5500	5600	65
70				3800	4100	4300	4400	4500	70
75					3100	3300	3400	3500	75
80					2200	2400	2500	2600	80

Notes to lifting capacity

Lifting capacities do not exceed 85% of tipping load. Weight of hook blocks and slings are part of the load, and are to be deducted from the capacity ratings. Consult operation manual for further details.

Note: Data published herein is intended as a guide only and shall not be construed to warrant applicability for lifting purposes. Crane operation is subject to the computer charts and operation manual both supplied with the crane.

LOAD CHART

STINGER 80-126

Mid Span Outriggers



 7,000 lbs

 (50%)

 360°

 40 to 126 ft

Standard ASME
B30.5

	Boom Length								
	40 ft	54 ft	66 ft	78 ft	90 ft	102 ft	114 ft	126 ft	
ft	lbs	lbs	lbs	lbs	lbs	lbs	lbs	lbs	ft
10	134800	102500							10
12	117900	102500							12
15	98300	99200	80600						15
20	61800	62900	63500	62200	56200				20
25	38200	39400	39900	40200	40400	40600			25
30	25800	27100	27600	27900	28200	28300	28500		30
35		19100	19500	19800	20000	20200	20300	20400	35
40		13900	14400	14700	14900	15000	15100	15200	40
45		10200	10800	11100	11300	11400	11500	11600	45
50			8100	8500	8700	8800	8900	9000	50
55			6000	6500	6600	6800	6900	7000	55
60				4800	5100	5200	5300	5400	60
65				3500	3700	3900	4000	4100	65
70				2300	2600	2800	2900	3000	70

Notes to lifting capacity

Lifting capacities do not exceed 85% of tipping load. Weight of hook blocks and slings are part of the load, and are to be deducted from the capacity ratings. Consult operation manual for further details.

Note: Data published herein is intended as a guide only and shall not be construed to warrant applicability for lifting purposes. Crane operation is subject to the computer charts and operation manual both supplied with the crane.

LOAD CHART

STINGER 80-126

Mid Span Outriggers



 5,000 lbs

 (50%)

 360°

 40 to 126 ft

Standard ASME
B30.5

	Boom Length								
	40 ft	54 ft	66 ft	78 ft	90 ft	102 ft	114 ft	126 ft	
ft	lbs	lbs	lbs	lbs	lbs	lbs	lbs	lbs	ft
10	133900	102500							10
12	117000	102500							12
15	97500	98300	80600						15
20	60400	61500	62000	62200	56200				20
25	37200	38400	38900	39200	39400	39600			25
30	23500	24800	25300	25600	25800	26000	26100		30
35		17300	17700	18000	18200	18400	18500	18600	35
40		12300	12900	13200	13400	13500	13600	13700	40
45		8900	9500	9800	10000	10100	10300	10300	45
50			7000	7300	7500	7700	7800	7900	50
55			5000	5500	5600	5800	5900	6000	55
60				3900	4200	4300	4400	4500	60
65				2600	2900	3100	3200	3300	65

Notes to lifting capacity

Lifting capacities do not exceed 85% of tipping load. Weight of hook blocks and slings are part of the load, and are to be deducted from the capacity ratings. Consult operation manual for further details.

Note: Data published herein is intended as a guide only and shall not be construed to warrant applicability for lifting purposes. Crane operation is subject to the computer charts and operation manual both supplied with the crane.

LOAD CHART

STINGER 80-126

Outriggers Fully Retracted

 15,000 lbs

 (0%)

 360°

 40 to 114 ft

Standard ASME
B30.5

	Boom Length							
	40 ft	54 ft	66 ft	78 ft	90 ft	102 ft	114 ft	
ft	lbs	lbs	lbs	lbs	lbs	lbs	lbs	ft
10	50900	51800						10
12	37100	38000						12
15	25000	26200	26500					15
20	14500	15600	16100	16400	16500			20
25	8800	9900	10400	10700	10900	11000		25
30	5200	6200	6700	7100	7300	7500	7500	30
35		3800	4300	4600	4800	5000	5100	35
40		1900	2400	2800	3000	3200	3300	40
45			1100	1400	1600	1800	1900	45



 11,000 lbs

 (0%)

 360°

 40 to 102 ft

Standard ASME
B30.5

	Boom Length						
	40 ft	54 ft	66 ft	78 ft	90 ft	102 ft	
ft	lbs	lbs	lbs	lbs	lbs	lbs	ft
10	46100	47000					10
12	33400	34400					12
15	22300	23400	23800				15
20	12600	13700	14200	14500	14600		20
25	7400	8400	8900	9300	9400	9600	25
30	4000	5100	5600	5900	6200	6300	30
35		2800	3300	3600	3900	4000	35
40			1600	2000	2200	2400	40

Notes to lifting capacity

Lifting capacities do not exceed 85% of tipping load. Weight of hook blocks and slings are part of the load, and are to be deducted from the capacity ratings. Consult operation manual for further details.

Note: Data published herein is intended as a guide only and shall not be construed to warrant applicability for lifting purposes. Crane operation is subject to the computer charts and operation manual both supplied with the crane.

LOAD CHART

STINGER 80-126

Outriggers Fully Retracted



 7,000 lbs

 (0%)

 360°

 40 to 102 ft

Standard ASME
B30.5

	Boom Length						
	40 ft	54 ft	66 ft	78 ft	90 ft	102 ft	
ft	lbs	lbs	lbs	lbs	lbs	lbs	ft
10	37800	38700					10
12	27100	28100					12
15	17800	18900	19300				15
20	9600	10700	11200	11400	11600		20
25	5200	6200	6700	7100	7200	7300	25
30	2300	3400	3900	4200	4500	4600	30
35		1400	1900	2300	2500	2700	35

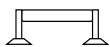

 5,000 lbs

 (0%)

 360°

 40 to 102 ft

Standard ASME
B30.5

	Boom Length						
	40 ft	54 ft	66 ft	78 ft	90 ft	102 ft	
ft	lbs	lbs	lbs	lbs	lbs	lbs	ft
10	34200	35100					10
12	24300	25300					12
15	15700	16800	17200				15
20	8100	9200	9700	10000	10100		20
25	4000	5100	5600	5900	6100	6200	25
30	1400	2500	3000	3300	3500	3700	30
35					1700	1900	35

Notes to lifting capacity

Lifting capacities do not exceed 85% of tipping load. Weight of hook blocks and slings are part of the load, and are to be deducted from the capacity ratings. Consult operation manual for further details.

Note: Data published herein is intended as a guide only and shall not be construed to warrant applicability for lifting purposes. Crane operation is subject to the computer charts and operation manual both supplied with the crane.

LOAD CHART

STINGER 80-126





With Jib, Outriggers Fully Extended





 15,000 lbs

 (100%)

 360°

Standard ASME
B30.5

33 ft Offsettable Jib						
 °	0°		15°		30°	
	 ft	lbs	 ft	lbs	 ft	lbs
77	40	12500	51	8500	56	6400
75	47	12000	56	8100	61	6200
73	53	11500	62	7800	67	6100
71	59	10900	67	7500	72	5900
68	68	9900	75	7100	79	5900
65	76	9200	82	6700	86	5600
62	83	8900	89	6400	93	5400
59	90	7900	96	6200	99	5300
55	99	6500	104	5900	107	5200
51	106	5300	111	5000	114	4800
47	113	4400	118	4200	121	4000
43	120	3600	125	3500	126	3400
38	127	2900	132	2800	132	2700
32	135	2200	139	2000	138	2000
25	143	1600	145	1500		
17	150	1100	150	1100		
0	152	1000				

57 ft Offsettable Jib						
 °	0°		15°		30°	
	 ft	lbs	 ft	lbs	 ft	lbs
77	49	6500	65	4500	76	3300
75	56	6400	71	4300	81	3200
73	63	6200	77	4100	87	3100
71	70	6000	83	3900	92	3000
68	80	5400	92	3700	100	2900
65	89	4900	100	3500	107	2800
62	98	4500	108	3300	114	2700
59	106	4200	115	3100	121	2600
55	116	3800	124	2900	129	2500
51	126	3500	132	2800	136	2500
47	134	3300	140	2700	143	2400
43	142	2900	147	2600	149	2300
38	150	2200	154	2100	156	2000
32	159	1600	162	1600	162	1600
25	167	1100	169	1100		
17	173	800	174	800		

Notes to lifting capacity

Lifting capacities do not exceed 85% of tipping load. Weight of hook blocks and slings are part of the load, and are to be deducted from the capacity ratings. Consult operation manual for further details.

Note: Data published herein is intended as a guide only and shall not be construed to warrant applicability for lifting purposes. Crane operation is subject to the computer charts and operation manual both supplied with the crane.

LOAD CHART

STINGER 80-126





With Jib, Outriggers Fully Extended





 11,000 lbs

 (100%)

 360°

Standard ASME
B30.5

33 ft Offsettable Jib						
 °	0°		15°		30°	
	 ft	lbs	 ft	lbs	 ft	lbs
77	39	12500	50	8500	56	6400
75	46	12000	55	8100	61	6200
73	52	11500	61	7800	66	6100
71	58	10900	66	7500	71	5900
68	66	9900	74	7100	79	5900
65	74	9200	81	6700	85	5600
62	82	8500	88	6400	92	5400
59	89	7200	95	6200	98	5300
55	97	5800	103	5400	106	5200
51	105	4700	110	4400	113	4200
47	113	3700	118	3600	120	3400
43	119	2900	124	2900	126	2700
38	126	2200	131	2200	132	2100
32	134	1600	138	1500	138	1500
25	141	1000	145	1000		

57 ft Offsettable Jib						
 °	0°		15°		30°	
	 ft	lbs	 ft	lbs	 ft	lbs
77	48	6500	64	4500	75	3300
75	56	6400	70	4300	80	3200
73	63	6200	76	4100	86	3100
71	70	6000	82	3900	91	3000
68	80	5400	91	3700	99	2900
65	89	4900	99	3500	106	2800
62	98	4500	107	3300	113	2700
59	106	4200	114	3100	120	2600
55	116	3800	123	2900	128	2500
51	125	3500	132	2800	135	2500
47	133	2900	139	2700	142	2400
43	141	2300	146	2100	148	2100
38	149	1700	154	1600	155	1600
32	157	1100	162	1100	161	1100
25	165	700	168	600		

Notes to lifting capacity

Lifting capacities do not exceed 85% of tipping load. Weight of hook blocks and slings are part of the load, and are to be deducted from the capacity ratings. Consult operation manual for further details.

Note: Data published herein is intended as a guide only and shall not be construed to warrant applicability for lifting purposes. Crane operation is subject to the computer charts and operation manual both supplied with the crane.

LOAD CHART

STINGER 80-126





With Jib, Outriggers Fully Extended





 7,000 lbs

 (100%)

 360°

Standard ASME
B30.5

33 ft Offsettable Jib						
	0°		15°		30°	
 °	 ft	lbs	 ft	lbs	 ft	lbs
77	39	12500	49	8500	57	6400
75	46	12000	55	8100	62	6200
73	53	11500	60	7800	67	6100
71	59	10900	66	7500	72	5900
68	67	9900	73	7100	79	5900
65	75	9000	81	6700	86	5600
62	82	7600	87	6400	93	5400
59	88	6400	94	5800	99	5300
55	97	5100	102	4600	106	4400
51	104	4000	110	3600	113	3400
47	111	3100	117	2800	120	2700
43	117	2400	123	2200	126	2100
38	125	1700	130	1600	132	1500
32	135	1000	137	900	138	900

57 ft Offsettable Jib						
	0°		15°		30°	
 °	 ft	lbs	 ft	lbs	 ft	lbs
77	49	6500	66	4500	75	3300
75	57	6400	72	4300	81	3200
73	64	6200	78	4100	86	3100
71	71	6000	84	3900	92	3000
68	81	5400	92	3700	99	2900
65	90	4900	100	3500	107	2800
62	98	4500	108	3300	114	2700
59	106	4200	115	3100	120	2600
55	116	3800	124	2900	128	2500
51	124	3000	132	2800	136	2500
47	132	2300	140	2100	143	2000
43	139	1700	146	1600	149	1600
38	147	1200	154	1100	155	1100
32	156	700	168	600	162	600

Notes to lifting capacity

Lifting capacities do not exceed 85% of tipping load. Weight of hook blocks and slings are part of the load, and are to be deducted from the capacity ratings. Consult operation manual for further details.

Note: Data published herein is intended as a guide only and shall not be construed to warrant applicability for lifting purposes. Crane operation is subject to the computer charts and operation manual both supplied with the crane.

LOAD CHART

STINGER 80-126





With Jib, Outriggers Fully Extended





 5,000 lbs

 (100%)

 360°

Standard ASME
B30.5

33 ft Offsettable Jib						
	0°		15°		30°	
 °	 ft	lbs	 ft	lbs	 ft	lbs
77	39	12500	50	8500	57	6400
75	47	12000	56	8100	62	6200
73	54	11500	61	7800	67	6100
71	60	10900	67	7500	72	5900
68	69	9900	74	7100	79	5900
65	76	8800	81	6700	86	5600
62	83	7200	88	6400	92	5400
59	89	5900	94	5400	98	5200
55	96	4600	102	4200	106	4100
51	104	3600	109	3200	113	3100
47	111	2800	116	2500	119	2400
43	118	2100	122	1900	125	1800
38	126	1300	129	1300	132	1200
32	135	700	137	600	138	600







57 ft Offsettable Jib						
	0°		15°		30°	
 °	 ft	lbs	 ft	lbs	 ft	lbs
77	48	6500	65	4500	75	3300
75	56	6400	71	4300	81	3200
73	63	6200	77	4100	86	3100
71	70	6000	83	3900	92	3000
68	80	5400	92	3700	100	2900
65	89	4900	100	3500	107	2800
62	97	4500	107	3300	114	2700
59	105	4200	114	3100	120	2600
55	115	3500	123	2900	129	2500
51	123	2700	131	2500	136	2200
47	131	2000	139	1900	143	1800
43	138	1500	146	1400	149	1400
38	147	900	153	800	155	800

Notes to lifting capacity

Lifting capacities do not exceed 85% of tipping load. Weight of hook blocks and slings are part of the load, and are to be deducted from the capacity ratings. Consult operation manual for further details.

Note: Data published herein is intended as a guide only and shall not be construed to warrant applicability for lifting purposes. Crane operation is subject to the computer charts and operation manual both supplied with the crane.

Boom, Jib and Rotation

	Four-section full power fully synchronized telescopic boom	
	Boom length	Retracted 39'7" ft Extended 126 ft
	Boom maximum tip height	136 ft
	Boom elevation angle range (min. / max.)	-4° / 78°
	Boom extend / retract speed	85 / 70 Sec
	Boom up / down speed	63 / 48 Sec
	Boom head	quick reeving
	360° continuous rotation	
	Electronic rated capacity indicator	
	Optional	
	Swing-On Jib – fixed length – can be offset to 0°, 15° or 30°	32 ft
	Maximum tip height with fixed jib	168 ft
	Swing-On Jib – adjustable length – can be offset to 0°, 15° or 30°	33 ft / 57 ft
	Maximum tip height with extended jib	193 ft
	5 sheave block	80 USt
	Sheave block	60 USt
	Quick reeving design	
	Top swivel ball with hook and latch (line capacity not included)	12 USt

Main and Aux Hoist, Rope and Hook

	Two speeds	Low Speed:	High Speed:
	First layer (no load speed)	191 ft/min	335 ft/min
	Fifth layer (no load speed)	275 ft/min	487 ft/min
	First layer	Low Speed:	High Speed:
	Fifth layer	18,450 lb	10,002 lb
		12,845 lb	6,963 lb
	Permissible line pull	Standard:	Rotation Resistant:
	Average breaking strength	14,600 lb	13,800 lb
		51,200 lb	69,200 lb
			600' of 3/4 in

Operator Cab



Sliding door
Sliding window on the right side
Tilting, tinted glass skylight
Removable front windshield
Six-way adjustable seat with armrest dual-axis electro-proportional joysticks
Joystick control for hoist(s), swing and boom elevation
Foot pedals for swing brake and engine rpm
Hand control for engine rpm
Hydraulic cab tilt (0-18 degrees)



Optional features for upper cab
Hydraulically powered air-conditioning and flameless heater
Work lights





Electronic rated capacity indicator with color display



Engine display provides operator cab readout of:
Diesel fuel and DEF levels, engine status lamps, engine RPM, crane hours-of-operation, coolant temperature, oil pressure and throttle diagnostics

Boom Rotation

	Glide swing with foot pedal actuated multi-disc brake and air actuated 360° house lock	
	Hydraulic driven double planetary reduction gear drive	2.2 rev/min

Counterweight

	Main counterweight, non removable, bolted to upper crane structure	3,000 lbs
	Removable counterweight package	2 x 2,000 lbs / 2 x 4,000 lbs

Outriggers

	X-pattern		
	Fully Extended	Front: Swing out and down to outer edge of pad	28'
		Rear: Swing out and down to outer edge of pad	27' 6"
	Mid Span	Front: Swing out and down to outer edge of pad	21' - 9"
		Rear: Swing out and down to outer edge of pad	21' - 2"

www.loadkingmfg.com

